

SkyTrak™

GPS VELOCITY SENSOR

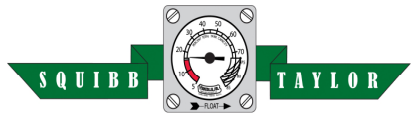

MANUFACTURED BY PARKER - PGI DIVISION

Installation, Operation & Maintenance Manual for Models SK2-1009-D, SK2-1009-M, & SK2-1009-R 9 Hertz GPS Velocity Sensors

March 2014 Form IOM-SK2-1009, Rev.02

SkyTrak is a GPS based velocity sensor that produces true ground speed pulses to equipment designed to interface with radar ground speed and wheel speed sensors. SkyTrak can be quickly transferred from vehicle to vehicle, provides high accuracy, and is easy to install and use. Simply make the connection to your monitor/control equipment, perform the same calibration you would use for other pulse sensors, and you're ready to go.



Physical Specifications

Size	3.50" Diameter x 2.14" High
Cable Length	15 feet
Power	4.8 to 16 Volts, 0.1 Amps max.
Connector	DICKEY-john®, Raven, or Micro-Trak® (depending on Model Number)
Operating Temp.	-40°C to +65°C (-40°F to +149°F)
Storage Temp.	-40°C to +80°C (-40°F to +176°F)
Humidity	100% Condensing

Performance Specifications

Velocity Accuracy	0.1 MPH (without SA)
GPS Update Rate	9 Hz.

Acquisition Rate

Start	< 1 minute Typical
-------	--------------------

Standard Features

- 9 updates per second provides high precision velocity readings
- Completely self-contained (GPS, antenna, and velocity-to-pulse converter)
- 50 Channel GPS receiver features high acquisition and tracking sensitivity
- Selectable output pulse rates ensures monitor compatibility
- 0.1 MPH accuracy from 0.5 to 50 MPH
- UV stable, polycarbonate enclosure
- Magnet mount simplifies installation
- Diagnostic LED's built into the cable help to quickly verify performance
- Consistent pulses/foot output unit to unit

While this information is presented in good faith and believed to be accurate, Individuals using this literature must exercise their independent judgment in evaluating product selection and determining product appropriateness for their particular purpose, system requirements and certifications. The manufacturer reserves the right to change product designs and specifications without notice.

Wire Color Code:
 Brown — Ground
 Blue — V+
 Green/Yellow — Output Signal

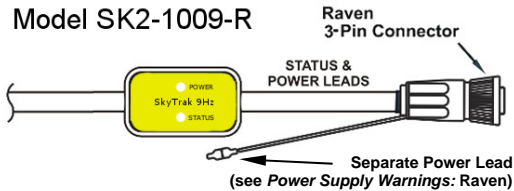
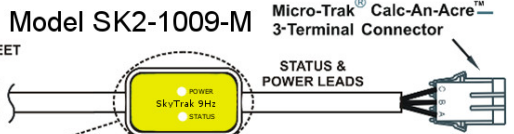
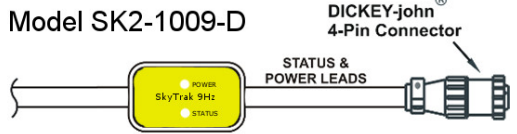
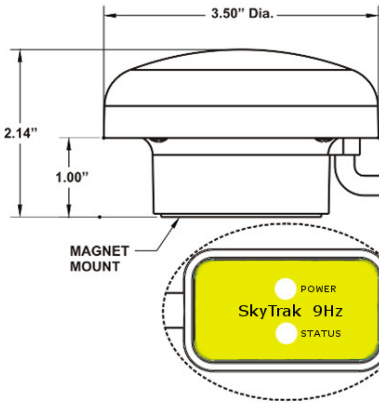

Mounting Considerations

- The SkyTrak mounting location should have a clear view of satellites on all sides.
- The SkyTrak unit must be mounted with the dome pointing to the sky.
- Avoid overhead metal structures that can block the satellite signals.
- Avoid mounting in areas with excessive vibration. An antenna that moves or sways may produce ground speed errors. The idea is to have the antenna move only when the vehicle is moving for accurate true ground speed measurement.
- To protect against dirt and debris entering the interior of the unit, avoid mounting in locations close to the ground.
- Make sure the cable can be safely routed to the connection point.
- SkyTrak can be mounted on a flat surface such as the roof of the vehicle cab.
- Position the SkyTrak status indicator so that it is easily viewable.

Power Supply Warnings:

DICKEY-john®

A Dickey-john® unit cannot be used in Raven applications by using a pin-for-pin adapter.

Many Raven devices do not supply adequate power to operate the SkyTrak directly. Therefore, a Raven specific connector must be supplied which provides for connection of an independent 12 volt power source to the SkyTrak. The SkyTrak model SK2-1009-R provides the necessary power connection for Raven applications.

It is also **very important** that a good ground is provided through the connector.

Raven

SkyTrak requires 4.8 to 16 volts at about 0.1 amps to operate. Although the Raven controller speed sensor interface connector provides 5 volts and ground to power some radar guns, it does not supply enough power for the SkyTrak sensor. **SkyTrak power must be supplied separately.** The positive lead of the SkyTrak power should be connected to the blue lead at the connector end of the SkyTrak harness. To simplify installation, a 1-pin crimp-on connector is provided. Using the connector will also make it easy to unplug the SkyTrak if it needs to be removed. Ground, or the power (-) connection, is provided through the controller's speed sensor interface connector **which must be a proper ground.** Choose a power source that is fused and switches off when the tractor is off.

While this information is presented in good faith and believed to be accurate, Individuals using this literature must exercise their independent judgment in evaluating product selection and determining product appropriateness for their particular purpose, system requirements and certifications. The manufacturer reserves the right to change product designs and specifications without notice.

Pulse Output Rate

The pulse rate for the SkyTrak is factory set to 58.94 PPS (pulses per second) / MPH (mile per hour). This setting will be suitable for most applications. If your application requires a different rate, a small jumper under the SkyTrak cover allows the pulse output rate to be changed.

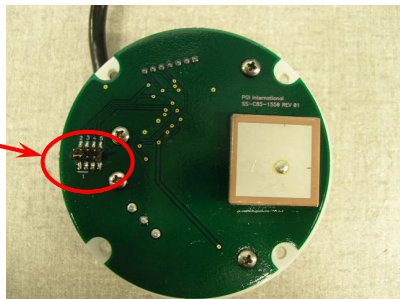
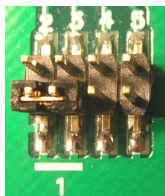

Available rates are...

Position 1	58.94 PPS/MPH — 40.1864 pulses/foot (Factory setting for most models)
Position 2	44.21 PPS/MPH — 30.1432 pulses/foot
Position 3	Reserved
Position 4	Reserved
Position 5	9.823 PPS/MPH — 6.6975 pulses/foot (Factory setting for Micro-Trak®)

The 58.94 PPS/MPH setting is shown here, with the jumper installed horizontally for Position 1. (Position 1 is the same as having no jumper installed.) For Positions 2, 3, 4, & 5, the jumper must be installed **vertically**, in line with the corresponding Position Number. For example, for 9.823 PPS/MPH, install the jumper vertically, over the two pins in line with the number 5.

Status LED Operation

- The SkyTrak power indicator will be on GREEN as long as power is applied to the unit.
- When power is first applied, the SkyTrak status LED will FLASH RED-GREEN-RED (when jumper is in position 1, 58.94 PPS/MPH) to indicate the pulse output jumper position. For example, if the jumper is in position 5, (to achieve the 9.823 PPS/MPH rate), the status LED will FLASH RED -GREEN-RED five times.
- While the SkyTrak GPS receiver is building the GPS satellite table, the status LED will be RED. The startup time depends on how long the unit has been off but is less than 1 minute.
- When the GPS is ready, the status LED will go from RED to GREEN when sitting still (not in motion). When in motion, the status LED will flash between RED and GREEN giving an ORANGE appearance.
- If the GPS loses or never acquires the satellite signal, the status LED will be solid RED (when moving or in the idle position) until a good signal is re-acquired.
- If the GPS is healthy and in idle, the status LED will be GREEN.

Calibration

After installing SkyTrak, your control equipment will need to be calibrated. Follow the calibration procedure for your controller or monitor as if you were using a radar or wheel speed sensor. Typically, this involves driving an accurately measured distance to determine a speed cal value for your system.

Before running the calibration, allow the SkyTrak to download a full satellite table by turning on SkyTrak where it has a clear view of the sky for about ten minutes. The status indicator should be solid green (using 4 or more satellites) before performing the calibration.

While this information is presented in good faith and believed to be accurate, Individuals using this literature must exercise their independent judgment in evaluating product selection and determining product appropriateness for their particular purpose, system requirements and certifications. The manufacturer reserves the right to change product designs and specifications without notice.

Troubleshooting

Problem	Possible Remedy
<ul style="list-style-type: none"> Unit does not power up (No LED light) 	<p>Check 12V and Ground connection at monitor.</p> <p>Disconnect the unit from the monitor and visually inspect the connector pins and cable for damage.</p> <p>If using a Raven monitor, ensure that the BLUE power wire is connected to a fused-switched 12V source.</p>
<ul style="list-style-type: none"> Status LED does not go GREEN after 15 minutes 	<p>Check that there are no obstructions for clear view of satellites on all sides of the SkyTrak. (i.e. Buildings, Metal Sheds, etc.)</p> <p>Disconnect unit from monitor, wait 5 seconds and reconnect. After reconnection, watch the Status LED.</p> <ul style="list-style-type: none"> If the LED flashes RED—GREEN—RED, the microprocessor is working properly and the problem lies within the GPS module; please contact Squibb-Taylor. If the LED does not flash, the problem lies within the circuitry of the unit; please contact Squibb-Taylor.
<ul style="list-style-type: none"> Status Led is GREEN, but no speed is displayed on the monitor 	<p>Cable assembly could be damaged or disconnected.</p> <p>Visually inspect the cable for any damage and ensure that it is properly connected to the circuit board inside the SkyTrak body. If the problem persists, please contact Squibb-Taylor.</p>

Warranty

- 1) If any defect within this warranty appears, Buyer shall notify Squibb Taylor immediately.
- 2) Squibb Taylor agrees to repair or furnish a replacement for, but not install, any product which within one (1) year from the date of shipment shall, upon test and examination by Squibb Taylor, prove defective within the above warranty.
- 3) No product will be accepted for return or replacement without the written authorization of Squibb Taylor. Serial Number for product must be presented at time of written authorization.

USER SAFETY RESPONSIBILITY STATEMENT FOR ALL PARKER PRODUCTS

FAILURE OR IMPROPER SELECTION OR IMPROPER USE OF THE PRODUCTS DESCRIBED HEREIN OR RELATED ITEMS CAN CAUSE DEATH, PERSONAL INJURY AND PROPERTY DAMAGE.

- This document and other information from Parker-Hannifin Corporation, its subsidiaries and authorized distributors provide product or system options for further investigation by users having technical expertise.
- The user, through its own analysis and testing, is solely responsible for making the final selection of the system and components and assuring that all performance, endurance, maintenance, safety and warning requirements of the application are met. The user must analyze all aspects of the application, follow applicable industry standards, and follow the information concerning the product in the current product catalog and in any other materials provided from Parker or its subsidiaries or authorized distributors.

To the extent that Parker or its subsidiaries or authorized distributors provide component or system options based upon data or specifications provided by the user, the user is responsible for determining that such data and specifications are suitable and sufficient for all applications and reasonably foreseeable uses of the components or systems.

DICKEY-john[®] is a registered trademark of the DICKEY-john Corporation.
 Micro-Trak[®] and Calc-An-Acre[®] are registered trademarks of Micro-Trak Systems Incorporated

While this information is presented in good faith and believed to be accurate, Individuals using this literature must exercise their independent judgment in evaluating product selection and determining product appropriateness for their particular purpose, system requirements and certifications. The manufacturer reserves the right to change product designs and specifications without notice.