

## Installation, Operation & Maintenance Manual for Models SK2-1001-D, SK2-1001-M, & SK2-1001-R 1 Hertz GPS Velocity Sensors

Form IOM-SK2-1001, Rev.03

**SkyTrak** is a GPS based velocity sensor that produces true ground speed pulses to equipment designed to interface with radar ground speed and wheel speed sensors. SkyTrak can be quickly transferred from vehicle to vehicle, provides high accuracy, and is easy to install and use. Simply make the connection to your monitor/control equipment, perform the same calibration you would use for other pulse sensors, and you're ready to go.

### Physical Specifications

Size	3.50" Diameter x 2.14" High
Cable Length	15 feet
Power	4.8 to 16 Volts, 0.1 Amps max.
Backup Battery	CR2032 Lithium Coin Cell
Connector	DICKEY-john®, Raven, or Micro-Trak® (depending on Model Number)
Operating Temp.	-30°C to +65°C (-22°F to +149°F)
Storage Temp.	-40°C to +80°C (-40°F to +176°F)
Humidity	100% Condensing

### Performance Specifications

Velocity Accuracy	0.1 MPH (without SA)
GPS Update Rate	1 Hz.
Backup Battery Life	> 3 years

### Acquisition Rate

Cold Start	< 52 seconds
Warm Start	< 9 seconds



### Standard Features

- Low cost alternative to radar type speed sensors
- Completely self-contained (GPS, antenna, and velocity-to-pulse converter)
- 16 Channel GPS receiver
- Battery backup for GPS satellite table reduces startup time
- Selectable output pulse rates ensures monitor compatibility
- 0.1 MPH accuracy from 0.5 to 50 MPH
- UV stable, polycarbonate enclosure
- Magnet mount simplifies installation
- Diagnostics LED's built into the cable help to quickly verify performance
- Consistent pulses/foot output from unit to unit

## Model SK2-1001-D

DICKEY-john®  
4-Pin Connector

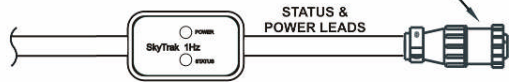

## Model SK2-1001-M

Micro-Trak® Calc-An-Acre™  
3-Terminal Connector

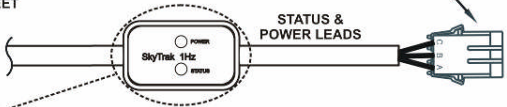

## Model SK2-1001-R

Raven  
3-Pin Connector

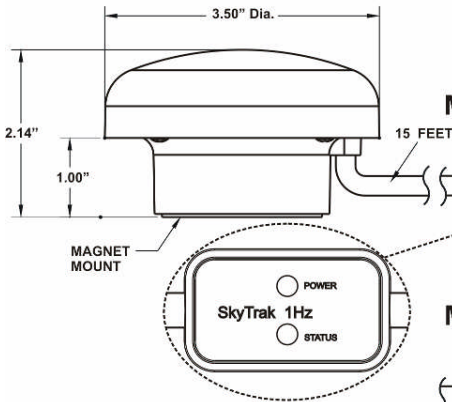
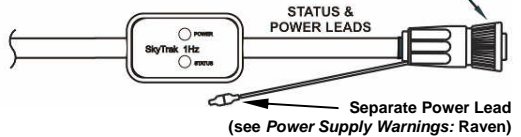

## Mounting Considerations

- The SkyTrak mounting location should have a clear view of satellites on all sides.
- The SkyTrak unit must be mounted with the dome pointing to the sky.
- Avoid overhead metal structures that can block the satellite signals.
- Avoid mounting in areas with excessive vibration. An antenna that moves or sways may produce ground speed errors. The idea is to have the antenna move only when the vehicle is moving for accurate true ground speed measurement.
- To protect against dirt and debris entering the interior of the unit, avoid mounting in locations close to the ground.
- Make sure the cable can be safely routed to the connection point.
- SkyTrak can be mounted on a flat surface such as the roof of the vehicle cab.
- Position the SkyTrak status indicator so that it is easily viewable.

## Power Supply Warnings:

### DICKEY-john®

A Dickey-john® unit cannot be used in Raven applications by using a pin-for-pin adapter.

Many Raven devices do not supply adequate power to operate the SkyTrak directly.

Therefore, a Raven specific connector must be supplied which provides for connection of an independent 12 volt power source to the SkyTrak. The SkyTrak model SK2-1001-R provides the necessary power connection for Raven applications.

It is also **very important** that a good ground is provided through the connector.

### Raven

SkyTrak requires 4.8 to 16 volts at about 0.1 amps to operate. Although the Raven controller speed sensor interface connector provides 5 volts and ground to power some radar guns, it does not supply enough power for the SkyTrak sensor. **SkyTrak power must be supplied separately.** The positive lead of the SkyTrak power should be connected to the blue lead at the connector end of the SkyTrak harness. To simplify installation, a 1-pin crimp-on connector is provided. Using the connector will also make it easy to unplug the SkyTrak if it needs to be removed. Ground, or the power minus connection, is provided through the controller's speed sensor interface connector **which must be a proper ground.** Choose a power source that is fused and switches off when the tractor is off.

## Selecting the Pulse Output Rate

The pulse rate for the SkyTrak is factory set to 58.94 PPS (pulses per second) / MPH (mile per hour). This setting will be suitable for most applications. If your application requires a different rate, a small jumper under the SkyTrak cover allows the pulse output rate to be changed.

Available rates are...

### Jumper

- |            |  |
|------------|--|
| Position 1 | 58.94 PPS/MPH — 40.1864 pulses/foot<br>(Factory setting for most models) |
| Position 2 | 44.21 PPS/MPH — 30.1432 pulses/foot                                      |
| Position 3 | Reserved   |
| Position 4 | Reserved   |
| Position 5 | 9.823 PPS/MPH — 6.6975 pulses/foot<br>(Factory setting for Micro-Trak®)  |

The 58.94 PPS/MPH setting is shown here, with the jumper installed horizontally for Position 1.

(Position 1 is the same as having no jumper installed.)

For Positions 2, 3, 4, & 5, the jumper must be installed **vertically**, in line with the corresponding Position Number. To gain access to the jumper, see the *Maintenance* section in this manual.

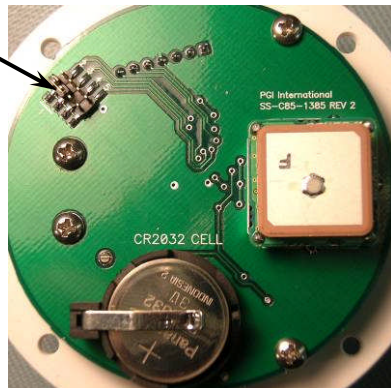

## Backup Battery Replacement

The backup battery should be replaced every three years. If the status indicator takes several minutes to switch to green when the unit is powered up after it has been off for only a short time, this is an indication that the battery needs to be replaced. To gain access to the battery, see the *Maintenance* section in this manual.

## Status LED Operation

- The SkyTrak power indicator will be on GREEN as long as power is applied to the unit.
- When power is first applied, the SkyTrak status LED will FLASH GREEN to indicate the pulse output jumper position. For example, if the jumper is in position 2, (to achieve the 44.21 PPS/MPH rate), the status LED will FLASH GREEN two times.
- While the SkyTrak GPS receiver is building the GPS satellite table, the status LED will be RED. The startup time depends on how long the unit has been off but is less than 45 seconds. The internal backup battery allows the GPS to keep the satellite table, even while SkyTrak is off. This can significantly speed up the start up time since the table does not need to be completely loaded - just updated.
- When the GPS is ready, the status LED will go from RED to GREEN (if the vehicle is stopped).
- When the vehicle is moving, the status LED will begin flashing between RED and GREEN at the output pulse rate after the GPS is ready. Usually the flashing status LED is so fast that it appears as though both the red and green are on at the same time.
- If the GPS loses the satellite signal, the status LED will go solid RED (even if the vehicle is moving) until a good signal is re-acquired.
- If the GPS is healthy, the status LED will be GREEN when the vehicle is stopped.

## Calibration

After installing SkyTrak, your control equipment will need to be calibrated. Follow the calibration procedure for your controller or monitor as if you were using a radar or wheel speed sensor. Typically, this involves driving an accurately measured distance to determine a speed cal value for your system.

Before running the calibration, allow the SkyTrak to download a full satellite table by turning on SkyTrak where it has a clear view of the sky for about ten minutes. The status indicator should be solid green (using 4 or more satellites) before performing the calibration.

## Maintenance

To gain access to the jumper and/or backup battery, remove the four small screws on the underside of the SkyTrak unit. Do not remove the Magnet screw in the center of the unit.

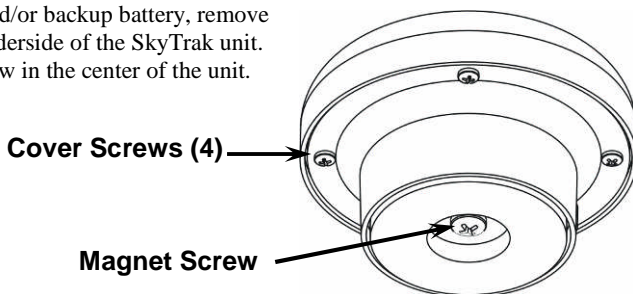

To change the jumper position, remove the jumper and re-install it vertically, in line with the desired Position Number. For example, for 9.823 PPS/MPH, install the jumper vertically, over the two pins in line with the number 5, as shown.

Replace and secure the cover, remount the SkyTrak unit, and re-calibrate.

Jumper installed at Position 1.

Jumper Position 5, for 9.823 PPS/MPH

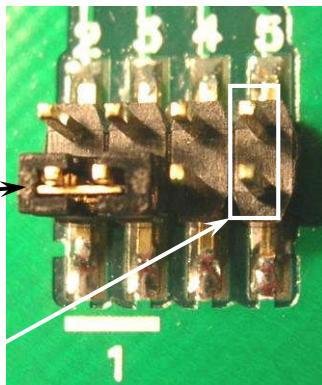

To replace the backup battery, press the locking tab downward and slide the battery out of the battery compartment.

Install a new CR2032 Lithium Coin Cell battery into the compartment with the positive (+) pole upward, until the locking tab is in the position shown here.

Locking Tab

Press Locking Tab downward

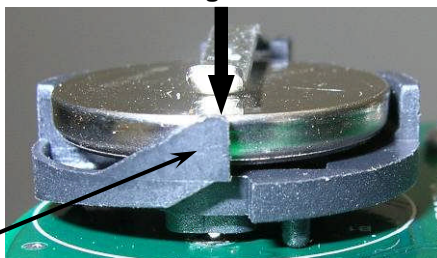

Replace and secure the cover, remount the SkyTrak unit, and re-calibrate.